

Data Sheet



Article number: 12858100025880

Description: KLEE-coil 858 100 025.880
M2,5 Brass

Measures

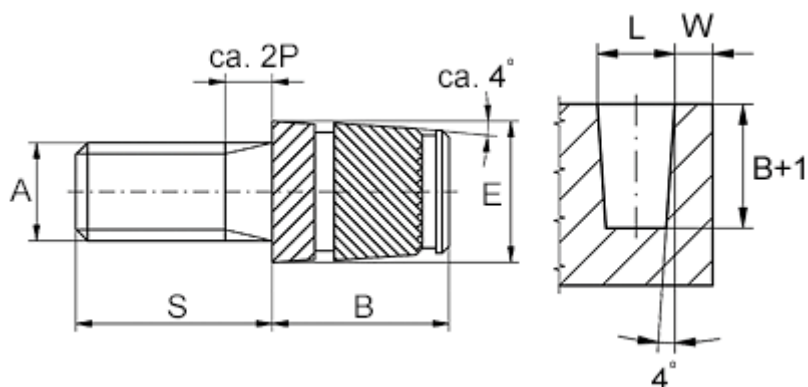

Male thread A	= M2,5x0,45
Min distance to edge W	= 1.5
Mounting length B	= 5.0
Outer diameter E	= 4.1
Pin length S	= 25
Recommended bore diameter W +0.1	= 3.8